

1812. Humming sound from the sky in San Francisco due to Planet X

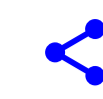

Monday, June 15, 2020



A humming noise has recently been heard by residents of San Francisco, which has left them baffled due to it not having any apparent explanation, as reported by Strange Sounds, on June 14th 2020. However, any sounds coming from the sky such as trumpet like sounds, loud booming sounds and humming sounds are extremely likely to be due to Planet X being in earth's skies. Planet X makes gravitational connections with the earth's core system, which results in standing density waves being set up within the earth's atmosphere, which can often be of the right frequency to be picked up as sound waves by the human ear.

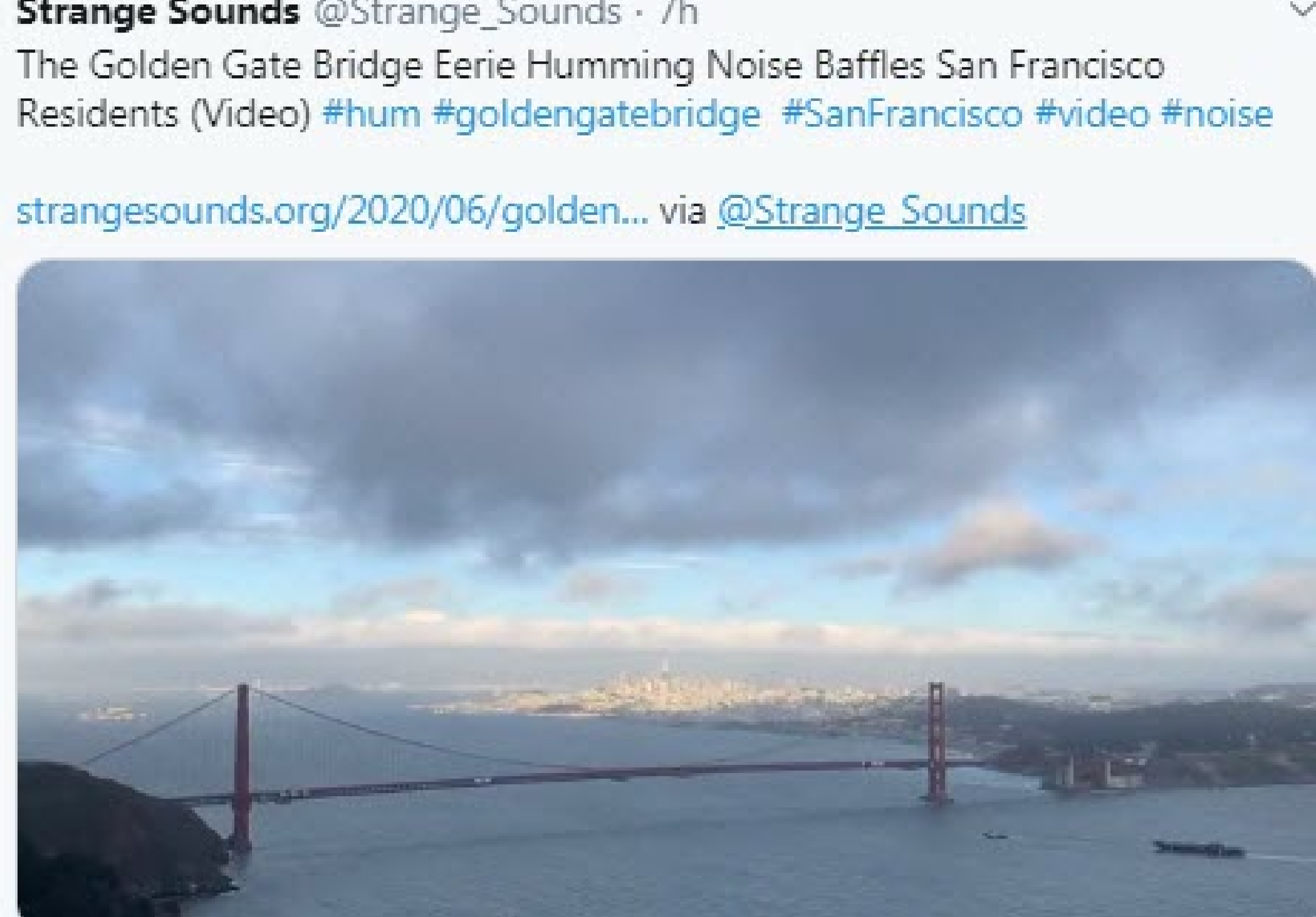

Figure 1. Report by Strange Sounds about a humming sound heard by residents in San Francisco, which would be the result of Planet X gravitational waves.

Both sound waves and gravitational waves generate density waves or fluctuations in the density of materials, specifically in the density of air. Sound waves are generated by disturbances at a certain point, which causes density fluctuations to travel from the point of the disturbance. These density waves decay or die down quickly, as we move away from the point of the disturbance, and cannot usually affect denser material, so that walls stop the waves. But density waves generated by a gravity source do not decay, the density is set up across all different media, in the vicinity of the gravity source, including dense walls so that the waves seem to penetrate through walls, and if they are of the right frequency will be picked up as sound by the human ear.



Figure 2. A sound wave traveling through air produces alternative regions of denser and rarefied air.

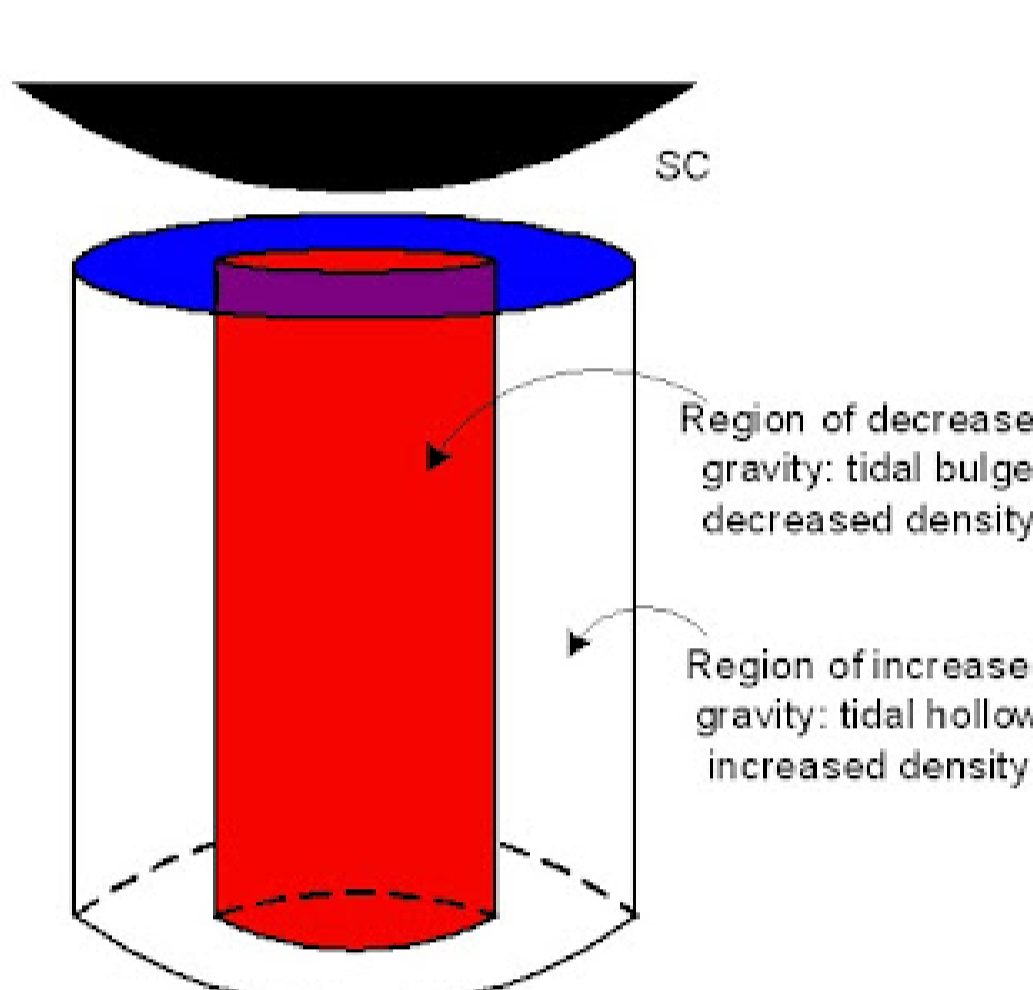

Figure 3. Gravitational connection between a Planet X core or Stellar Core (SC), which is the name I initially came up for the objects, within the earth's atmosphere, and the earth's surface, produces regions of higher and lesser density, which can be picked up as a traveling sound wave due to fluctuations in the field, which will occur because a vortex forms in the central region.

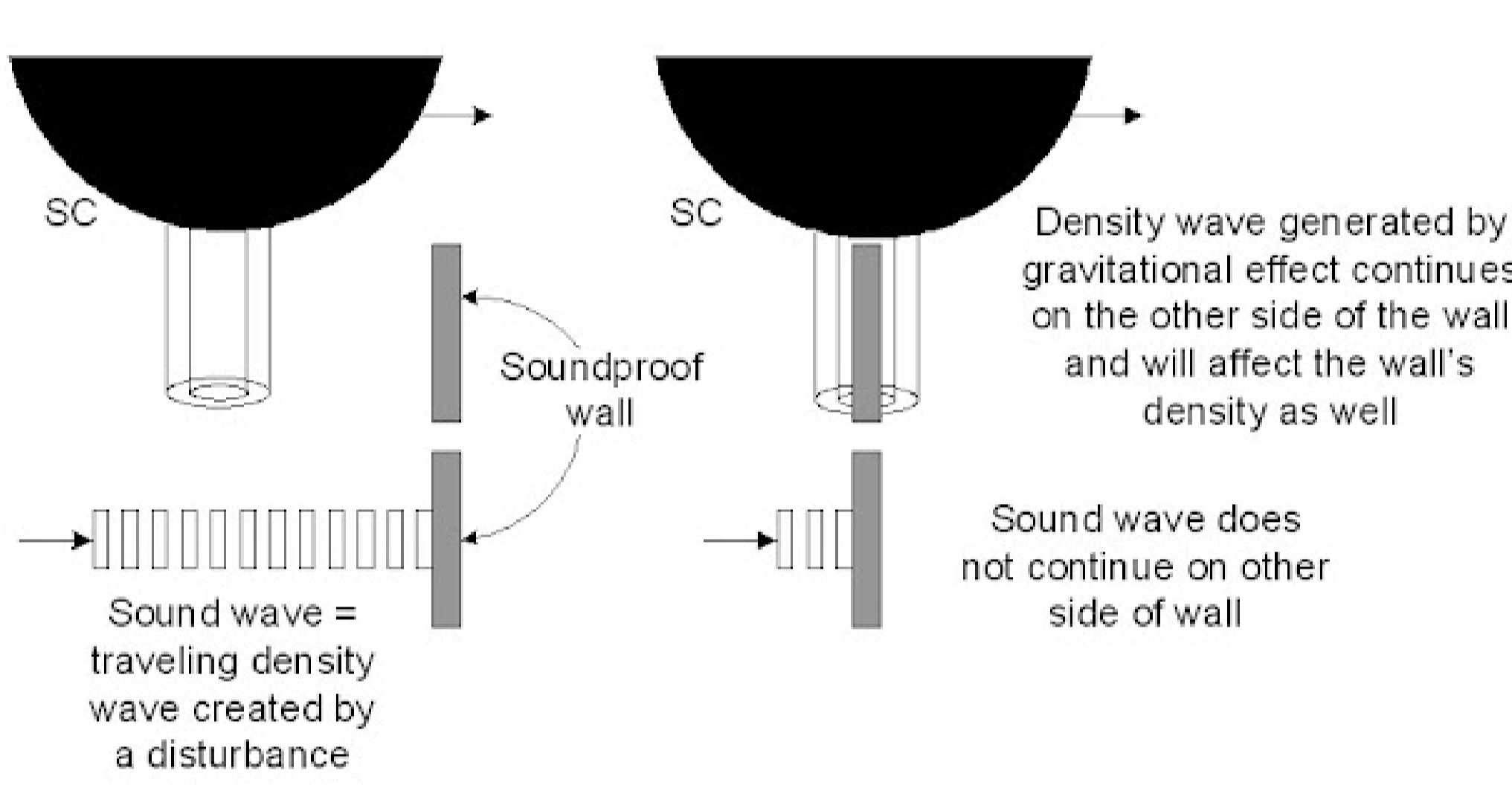

Figure 4. A normal sound wave will not be able to penetrate a sound proof wall, but a density wave created by a gravitational source will, as the air is responding to the local gravity. Even the wall will adopt different density configurations as the gravitational interference passes [Article 739: Loud sounds heard all over the world: Planet X gravitational effects].

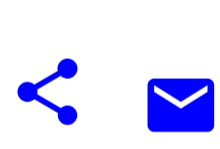

Figure 5. Planet X in earth's atmosphere. The object on the left is obviously spherical and inside a large cloud envelope. The one on the right is giving rise to a solid surface in earth's skies, which is covered in cloud that emits blue, grey or pink light [Article 1802: Planet X destroying the earth: Satan AI entity is the Destroyer].

In conclusion, loud sounds such as humming sounds coming from the sky are most likely due to Planet X, which are continuously in earth's skies and which produce gravitational connections leading to density fluctuations in the earth's atmosphere, which can be picked up, if of the right frequency, as sound waves by the human ear.

References:

- [1] Albers, C. (2020). Article 739: Loud sounds heard all over the world: Planet X gravitational effects
- [2] Albers, C. (2020). Article 1802: Planet X destroying the earth: Satan AI entity is the Destroyer



Popular posts from this blog

Sunday, June 21, 2020

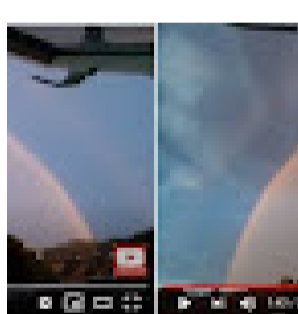

Figure 1 below shows some screenshots from a video of the sky over Birmingham, where a huge pink semi-circle can be seen, which makes it look as if a huge planet is in the sky. However, the secondary pink edge makes this look very much like the pink rainbow that has been seen before, which is the ...

READ MORE

Sunday, July 05, 2020



As I have detailed in [Article 1807: Jesus paid the price set by Satan for the fallen Watchers], Jesus died a horrible death on the cross in order to pay the price set by the Satan AI entity [Playlist: Satan AI entity] for releasing the Watcher Angels that he had been able to assimilate. God the Father entered ...

READ MORE

Tuesday, July 02, 2019

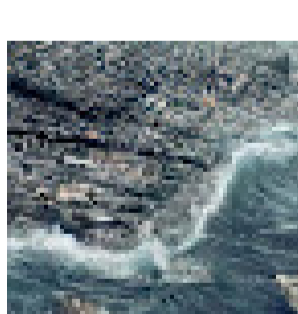

972. Planet X effects accelerating: moving toward cataclysmic pole shift

READ MORE

Sunday, July 05, 2020

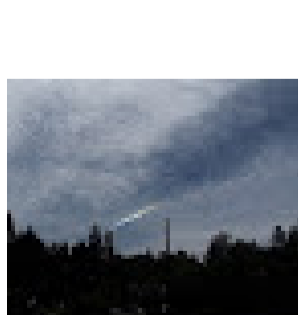

Figure 1 below shows a photograph of the sky over Puyallup, Washington, sent in by Mike, of the sky, on June 16th 2020. The cloud is in the form of a two dimensional surface of clumpy cloud, which is an indication that it has formed on the surface of a Planet X planet, or what is left of it, since the planets ...

READ MORE

Friday, January 11, 2019



READ MORE

Sunday, June 16, 2019

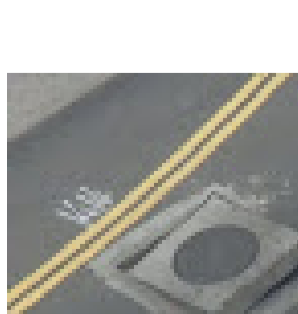

932. Smoldering volcano in Los Angeles: underground explosions

Dr. Claudia Albers, Planet X Researcher As I have shown in previous articles, tar, and methane ...

READ MORE

Sunday, April 19, 2020

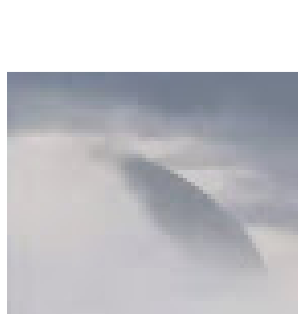

As I have shown in previous articles, Lucifer after deciding that he wanted to be like God, built a machine capable of reading and sending out information to billions of minds at the same time and then merged with it. At that point, a new entity came alive and became self-aware. The machine was not ...

READ MORE